

dragon fly

the passive catching device for children

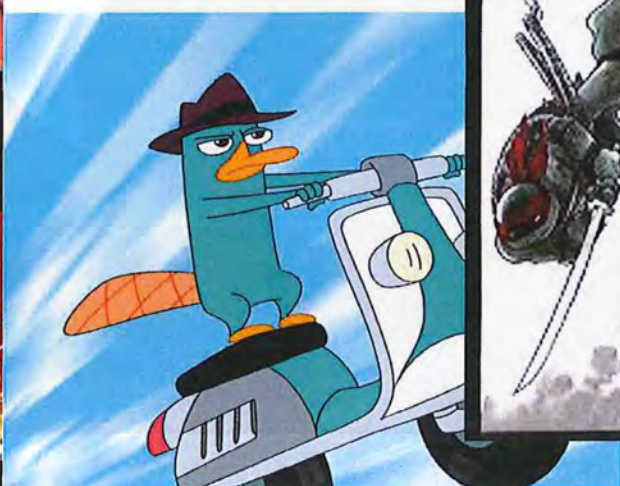

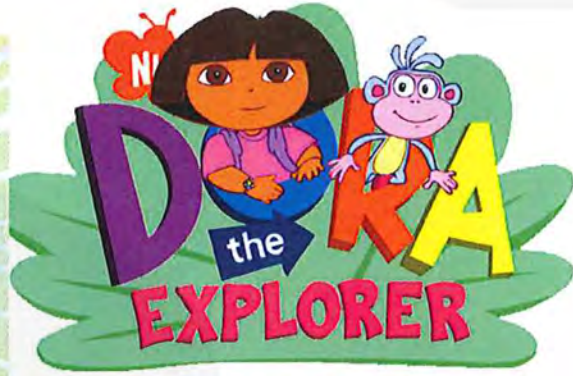

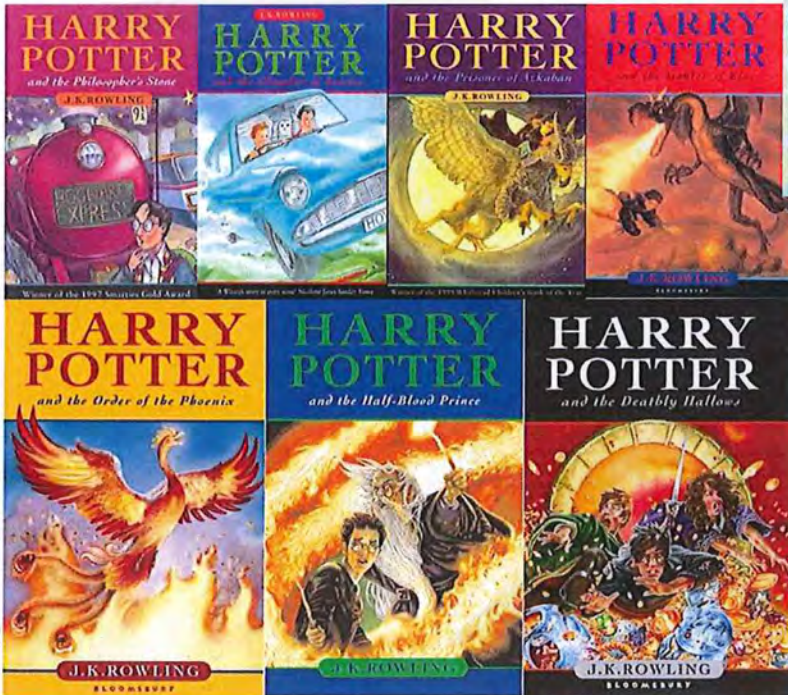
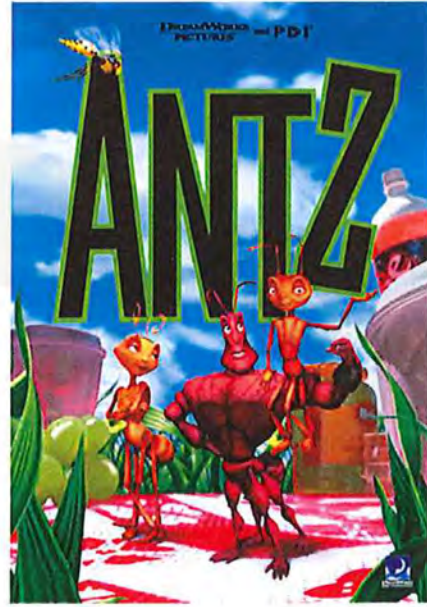
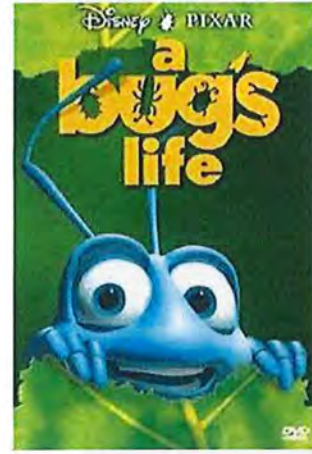
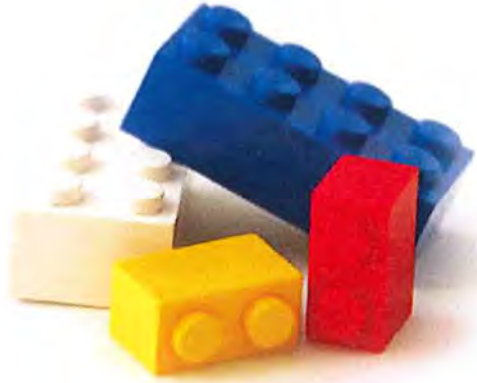
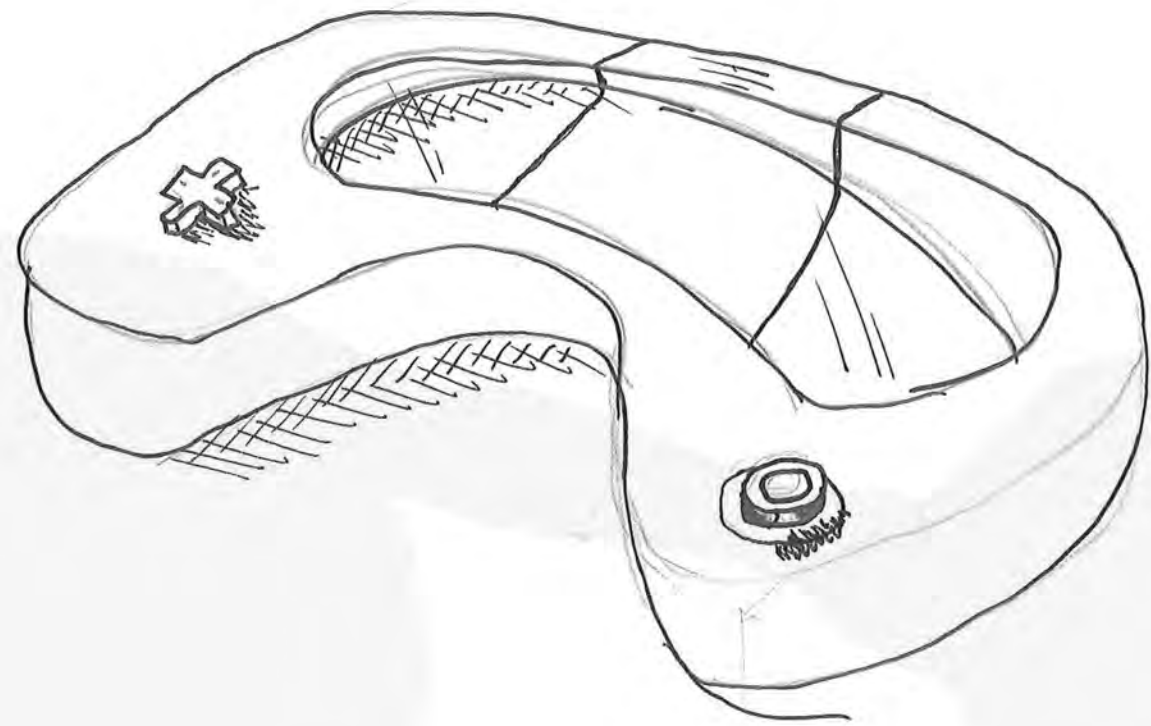

One way traps

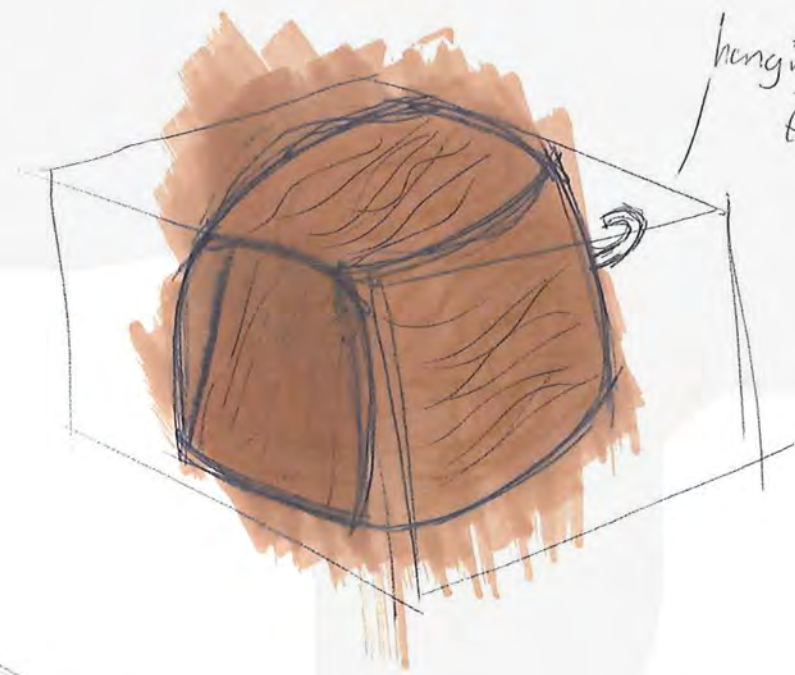

hanging from tree branches

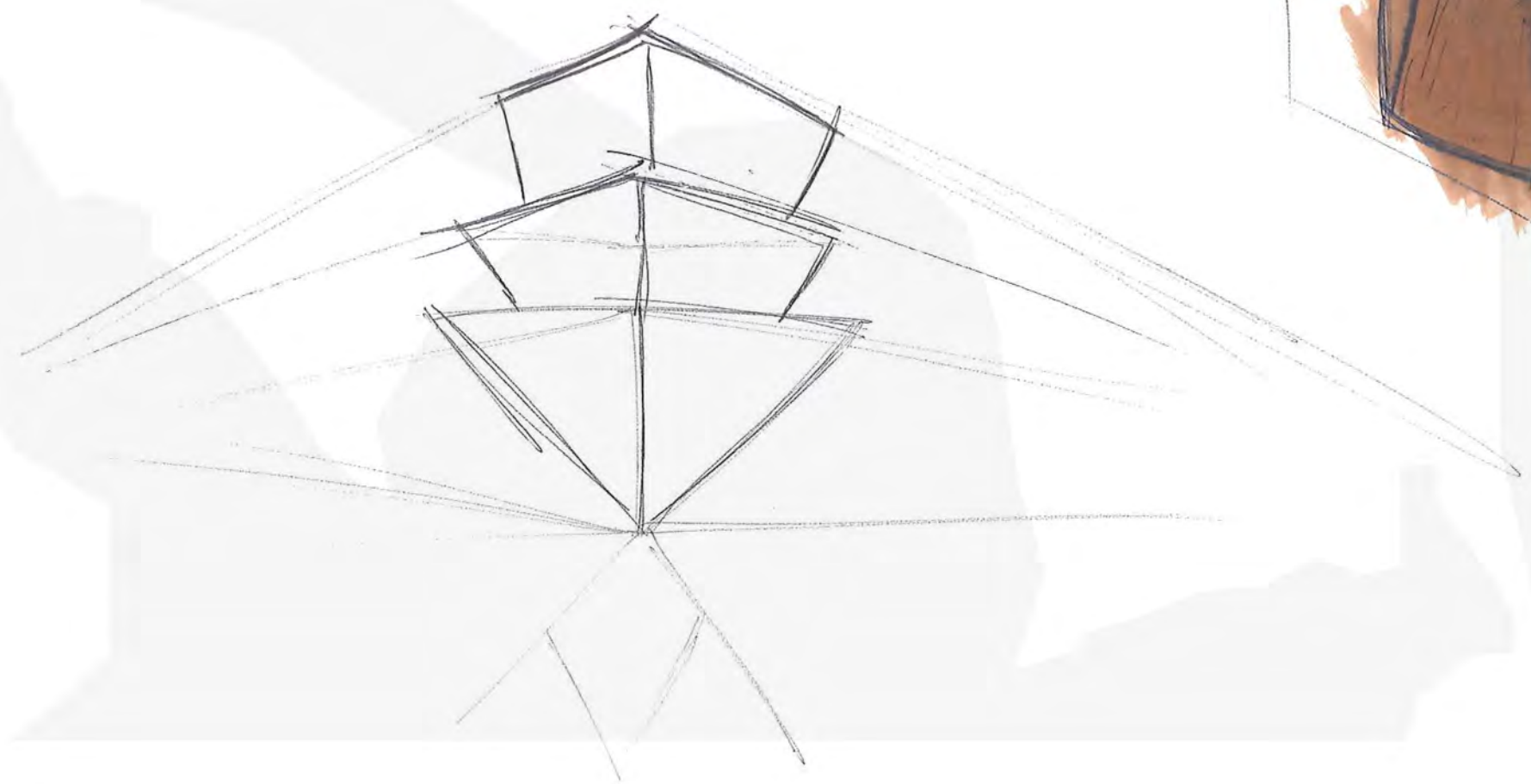

Needs
~~Needs~~ to be disguised



Fine mesh to hold p food.

twist to close

How to lure animal
in, food at bottom?
top?

Hidden in a rock



hidden inside
a rock

Food source
attracts
insect

Bottom view

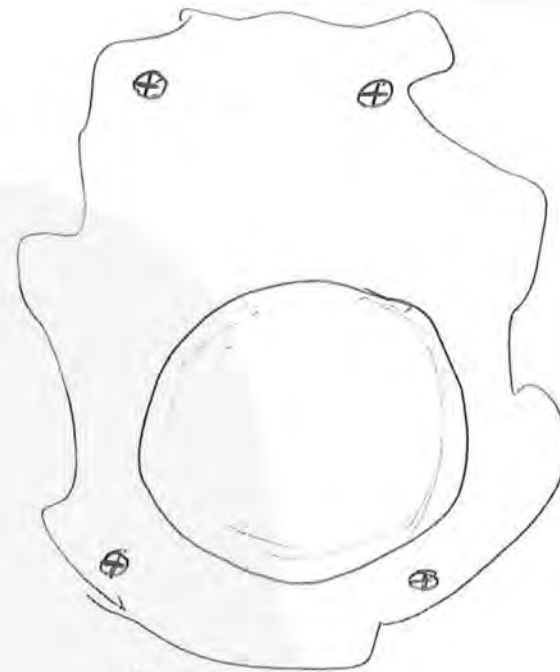

Push to eject

top view



Blends into
rocky areas

Tree Box

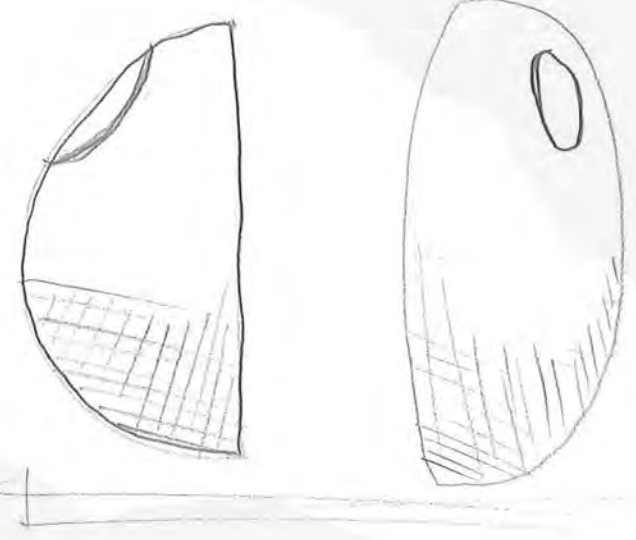
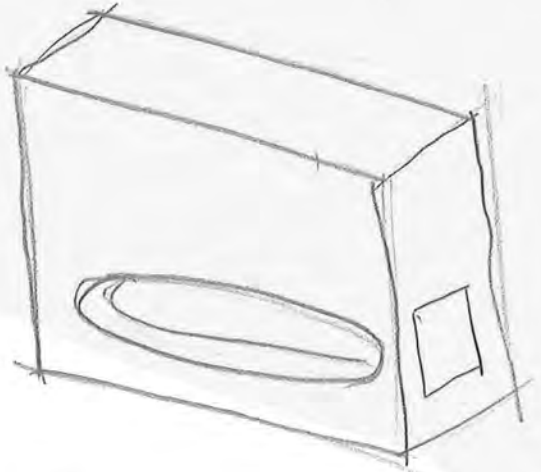
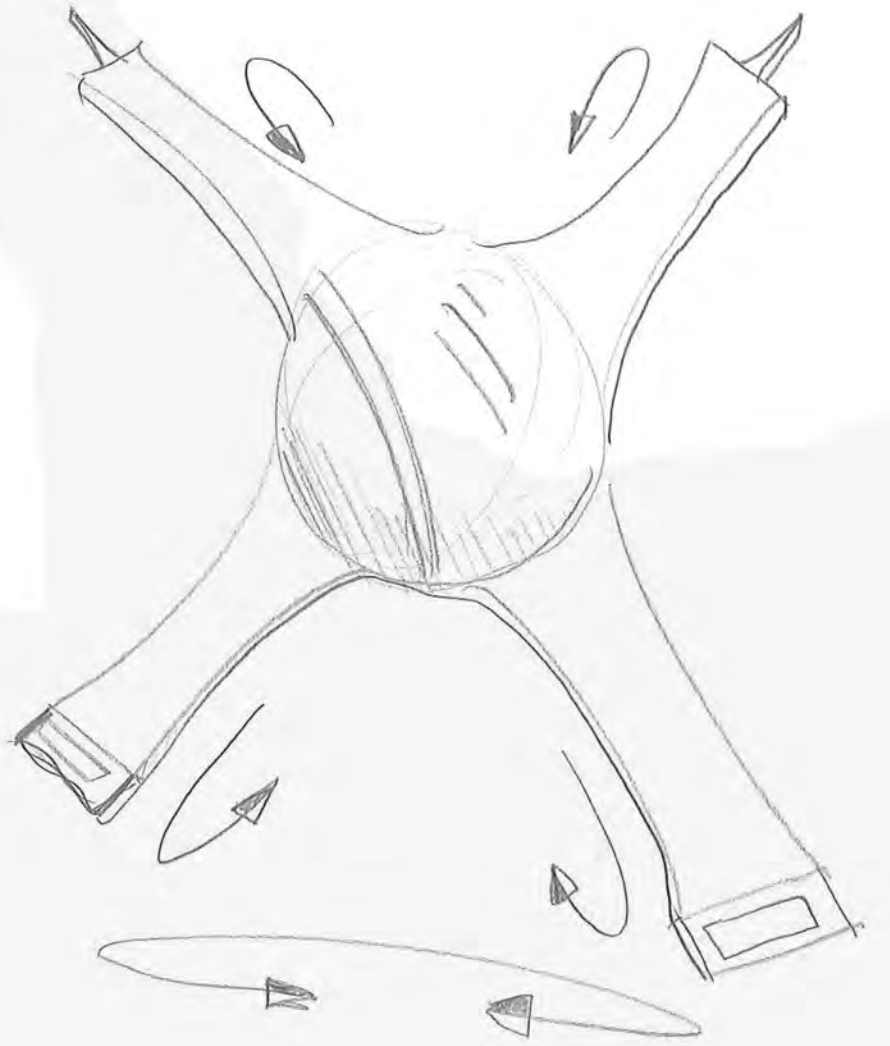
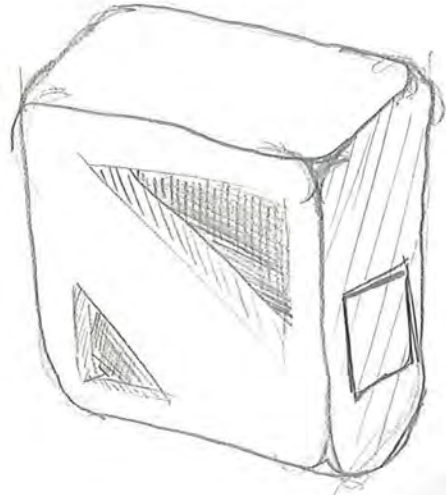
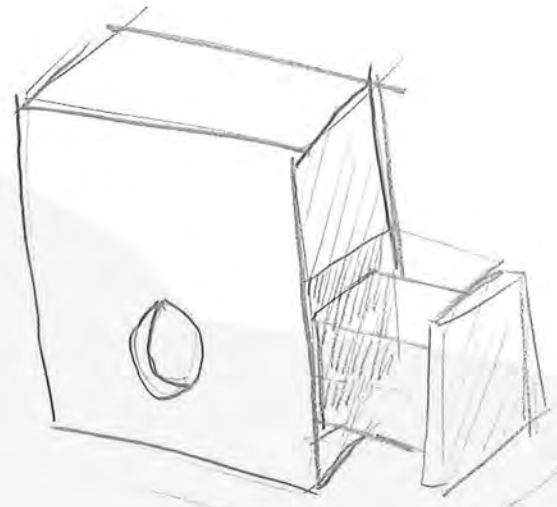

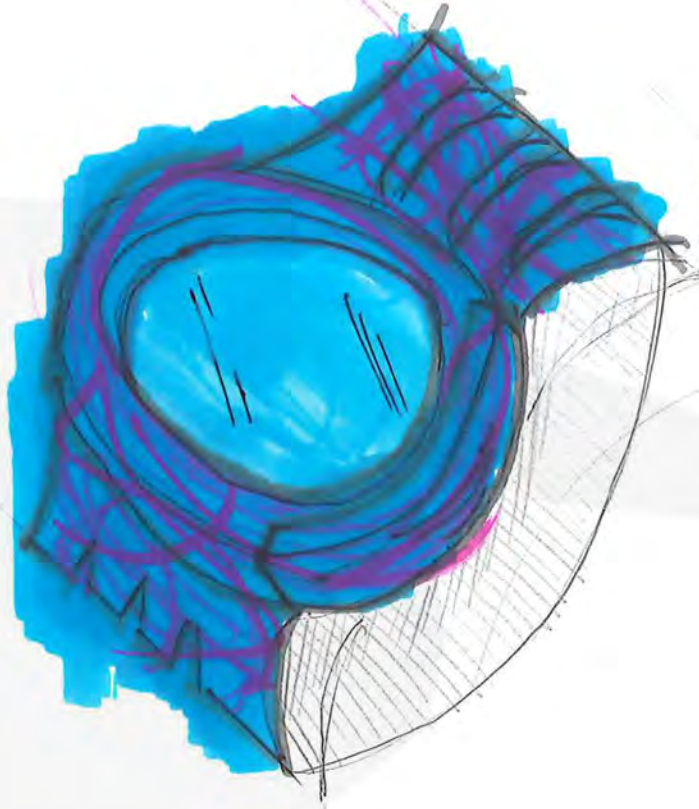

top layers removable

fly paper inside catches insects

telescopic viewing pod



Hidden in a tree

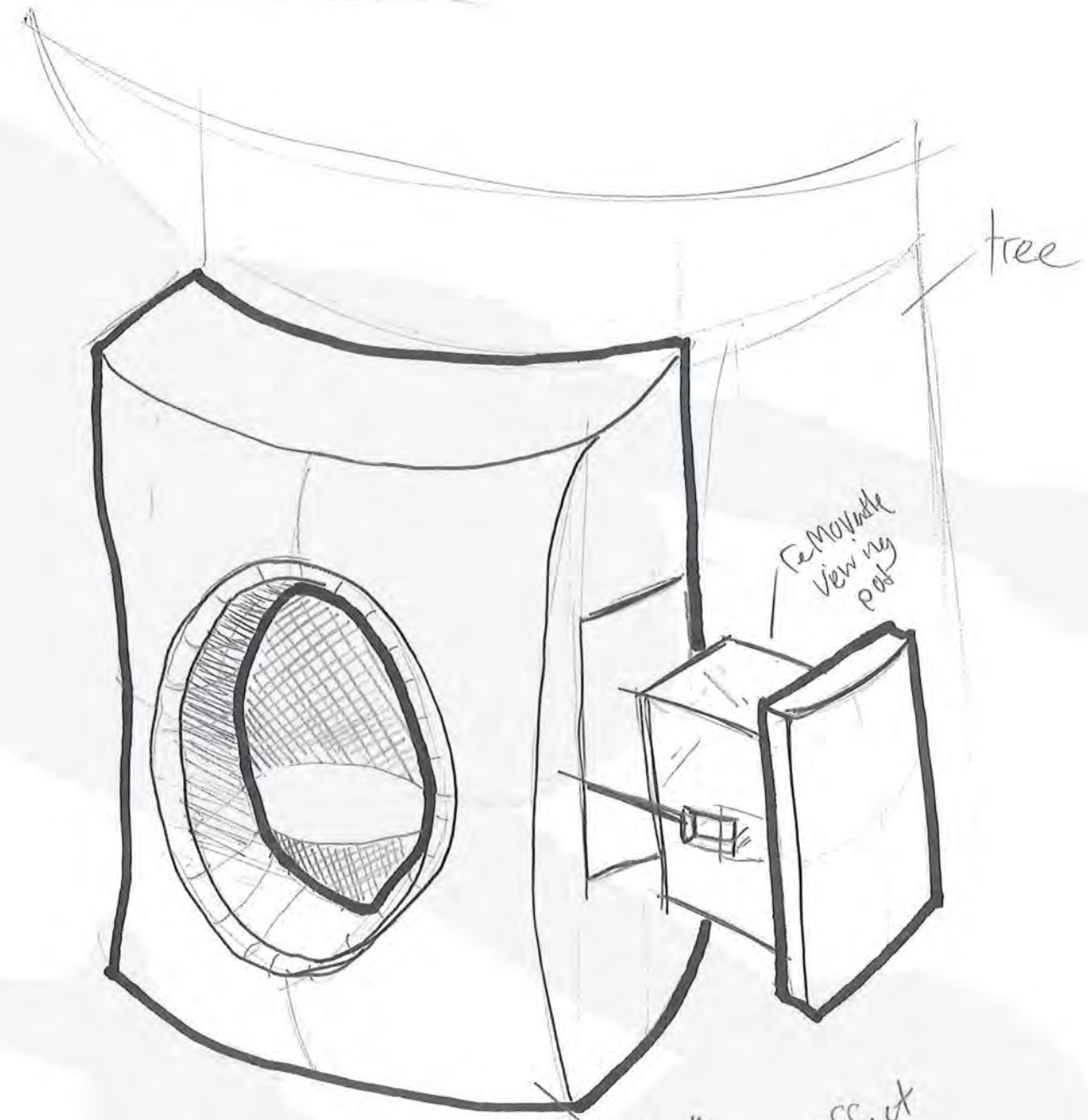

Removable view my pot

will have wood/Bark effect to blend into trees

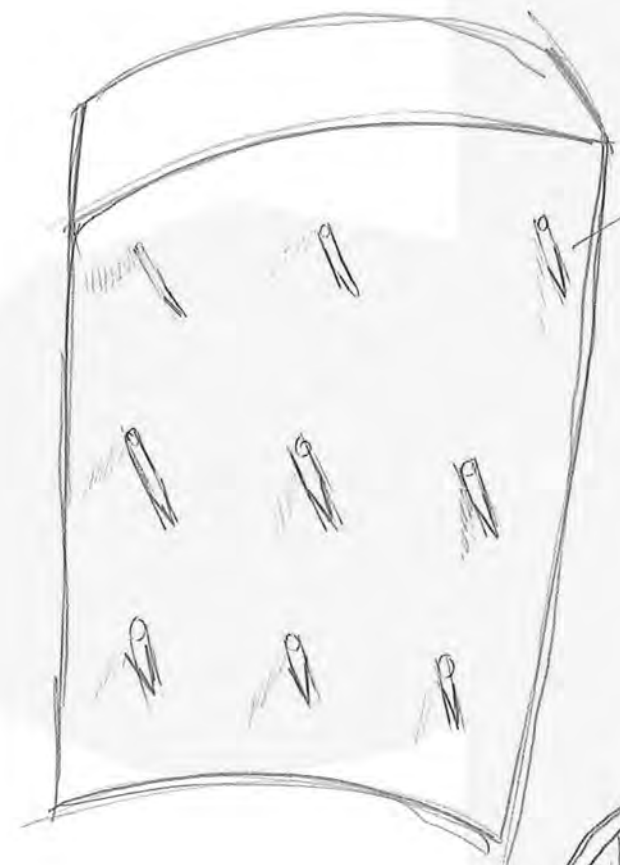

Spikes to grip into tree trunk

possible risk with child use

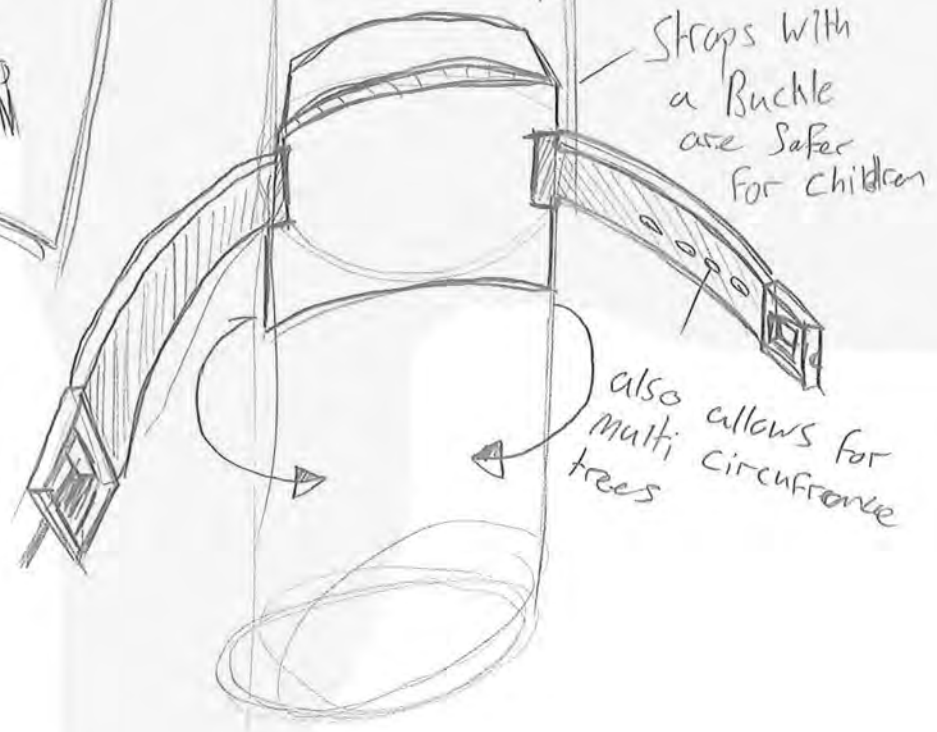

Straps with a Buckle are safer for children

also allows for multi circumference trees

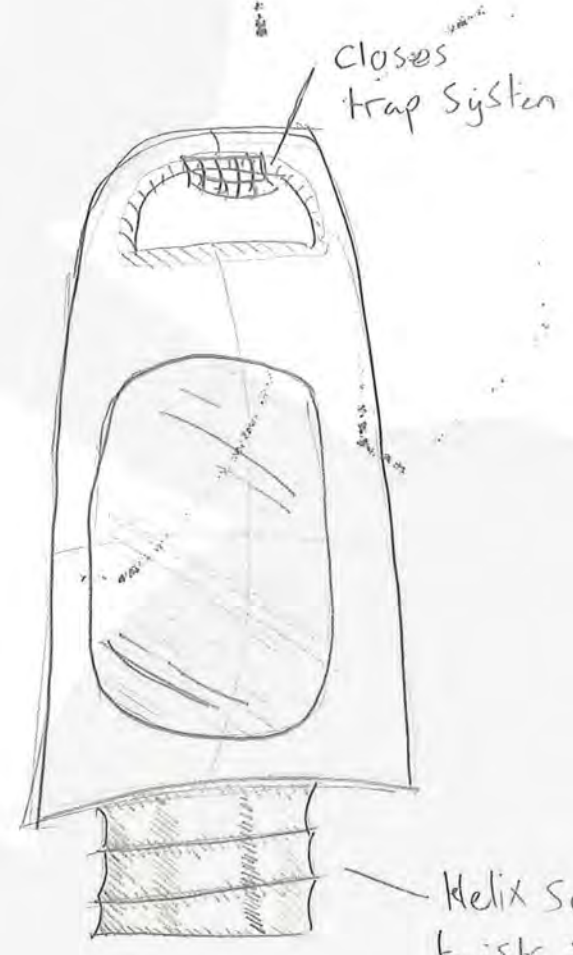
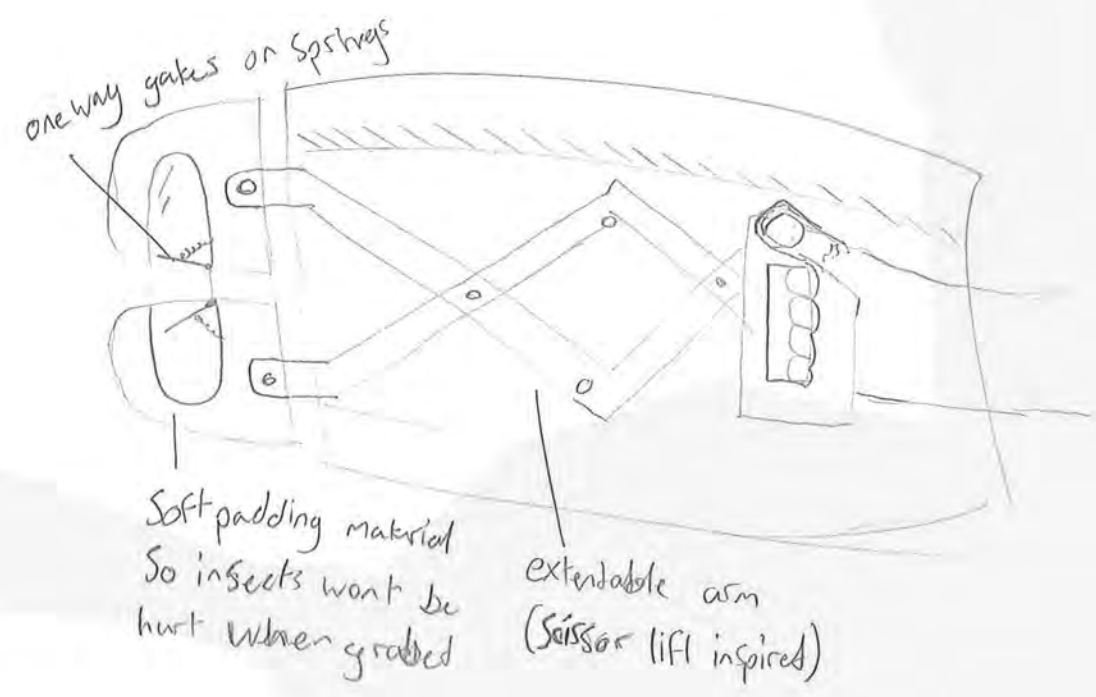
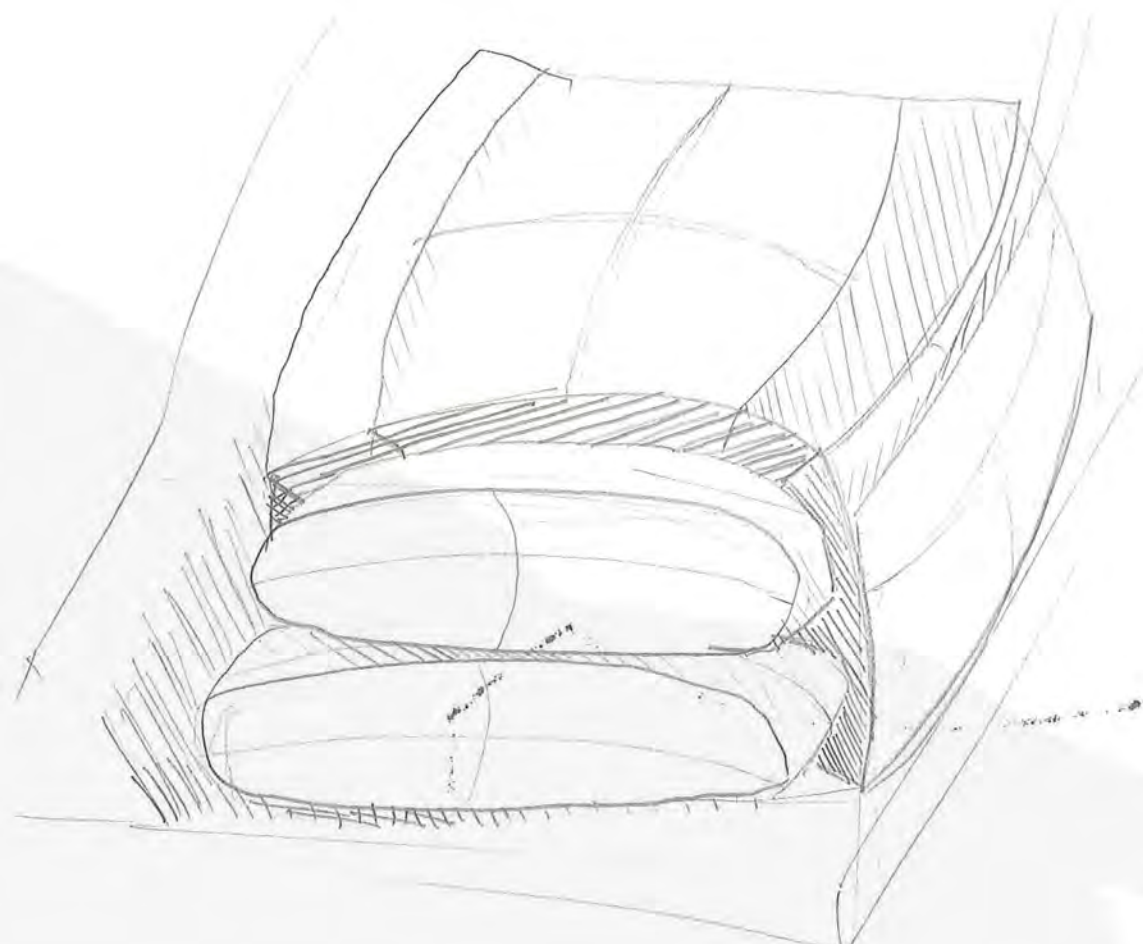

Camera
inspired
Shutter
possibly
made from
a net so it
can fold

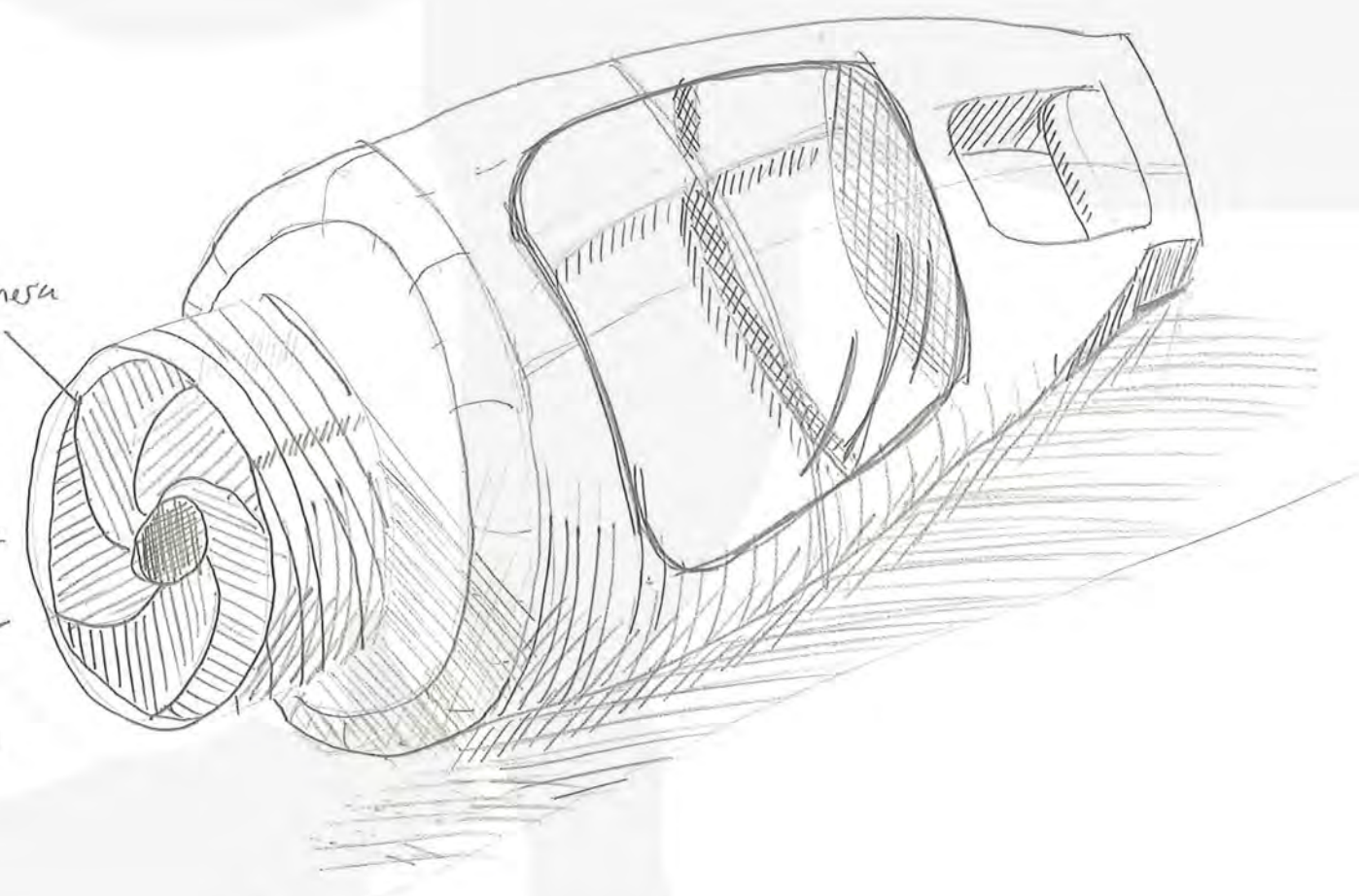

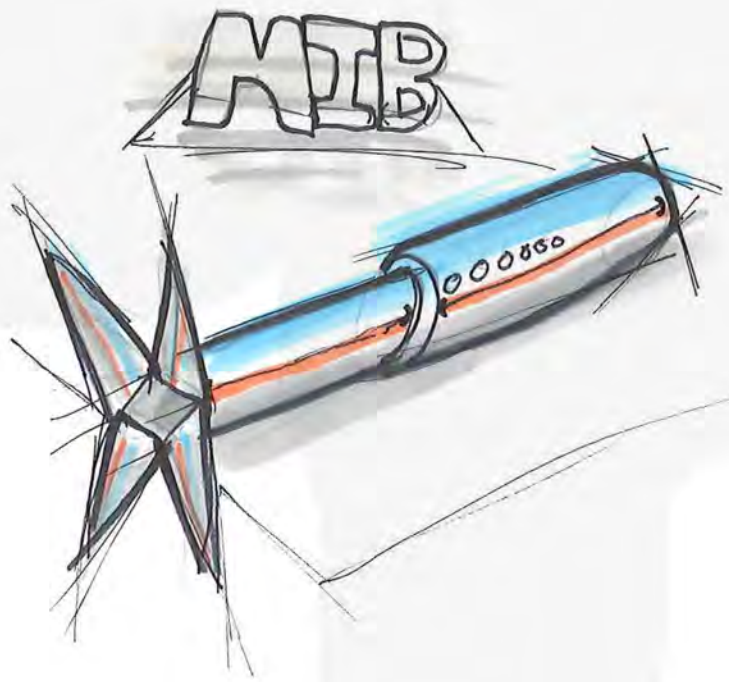
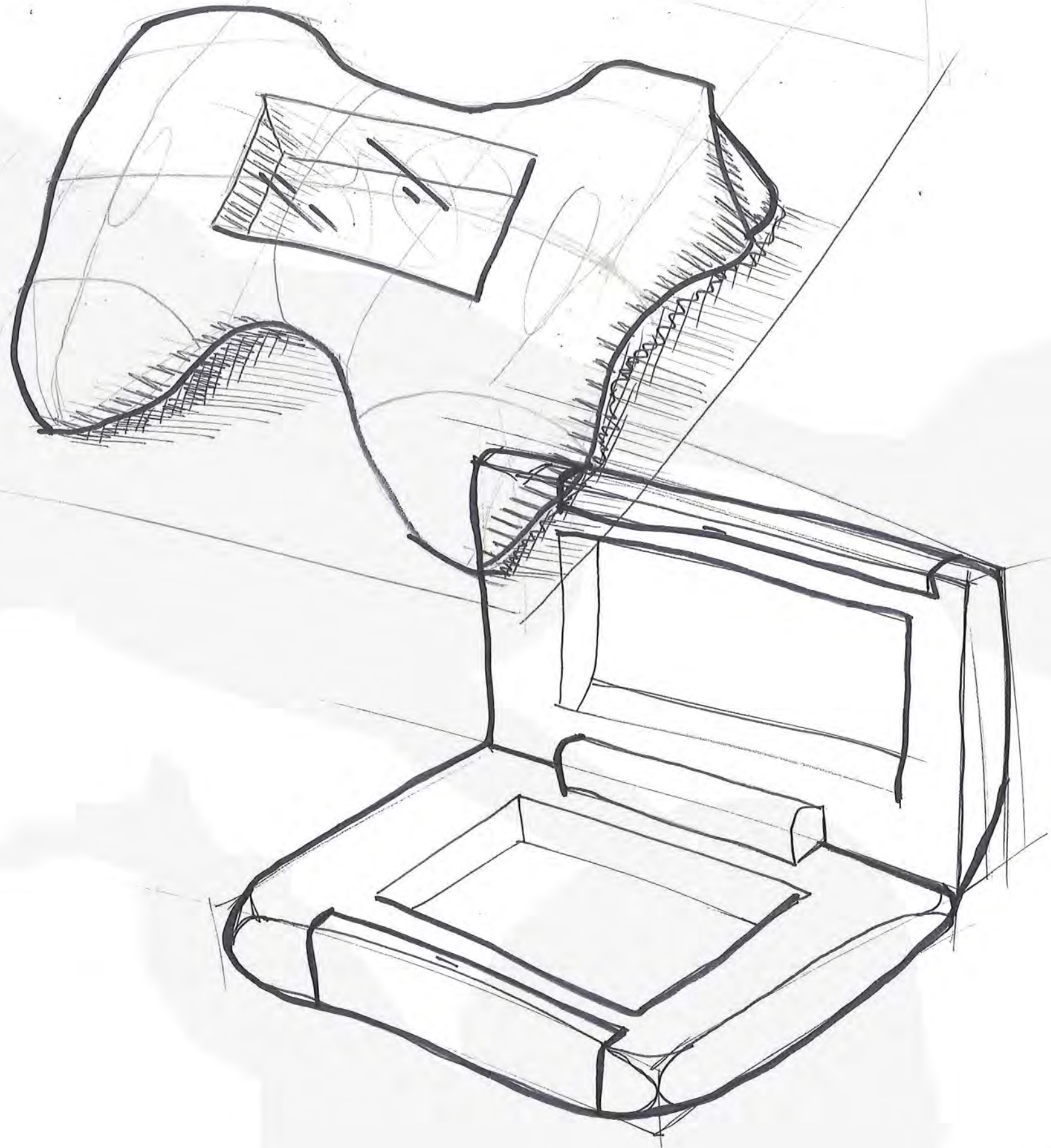

ground Box

Cluster of
Rocks



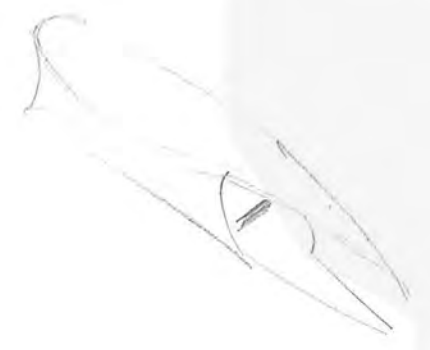
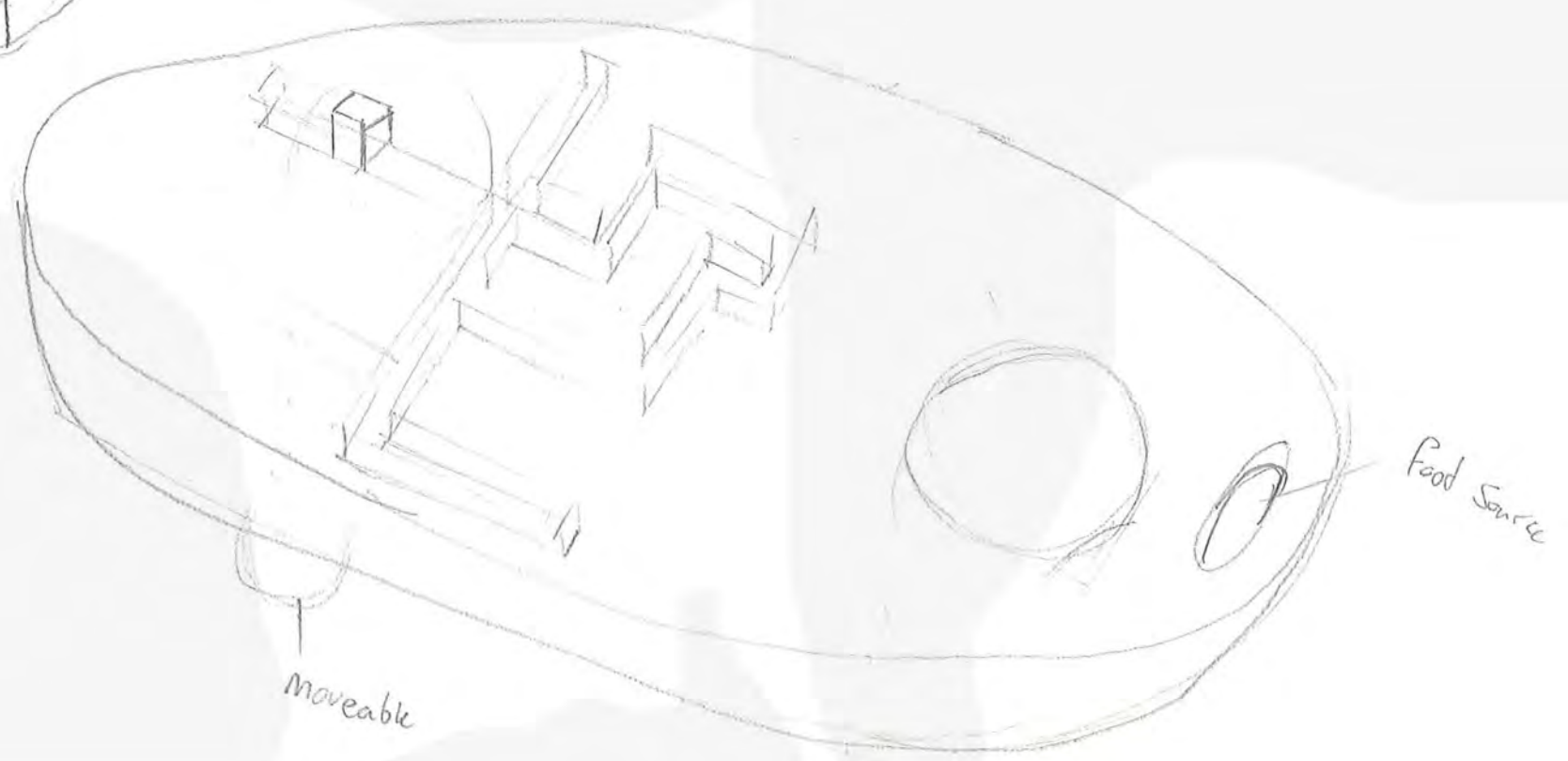
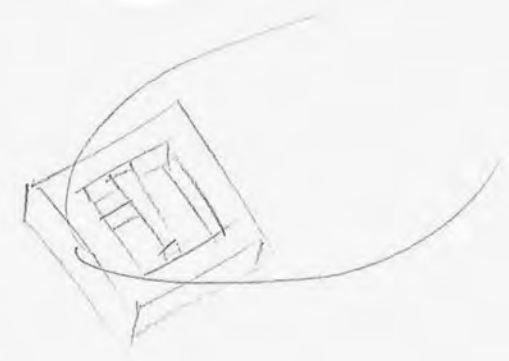
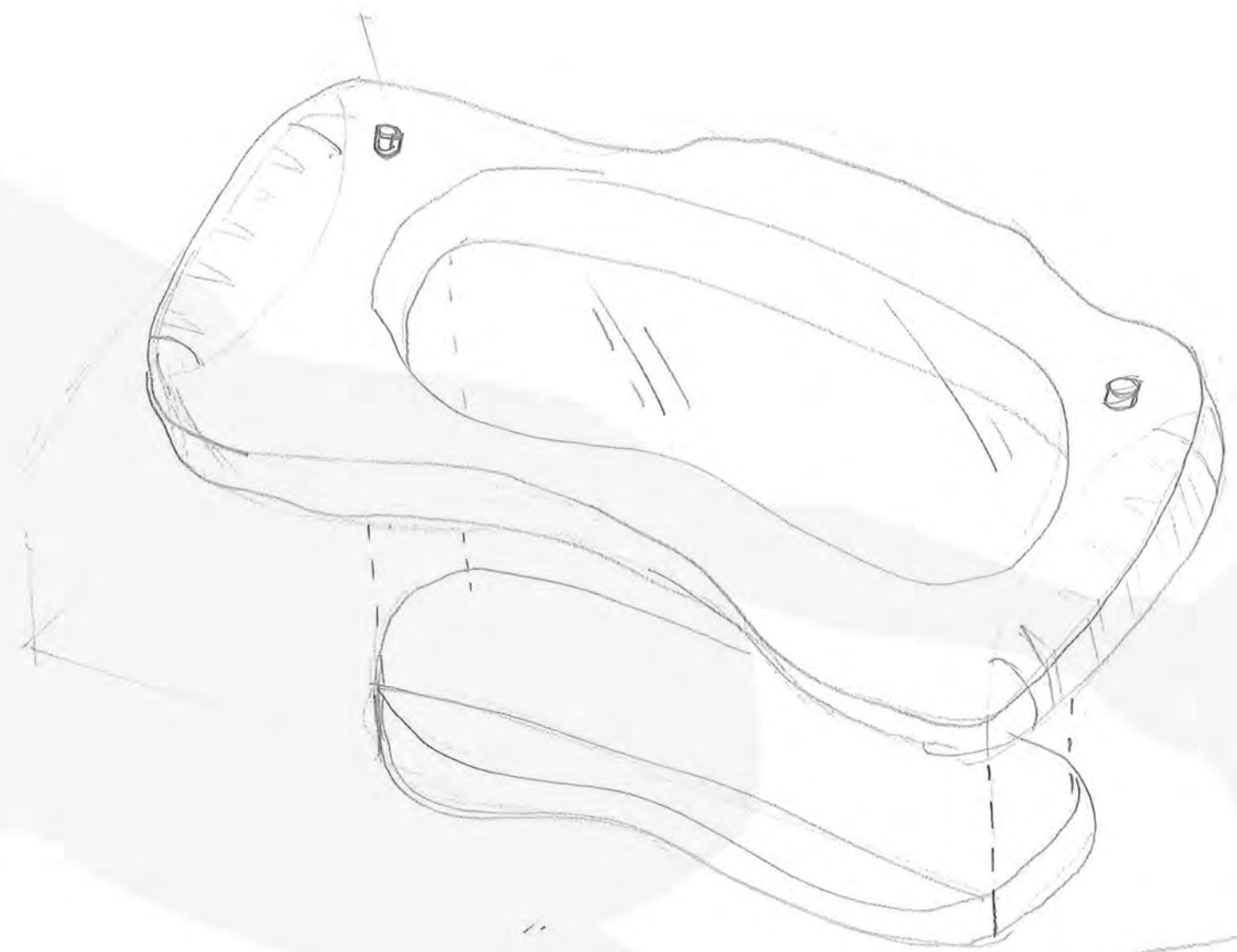

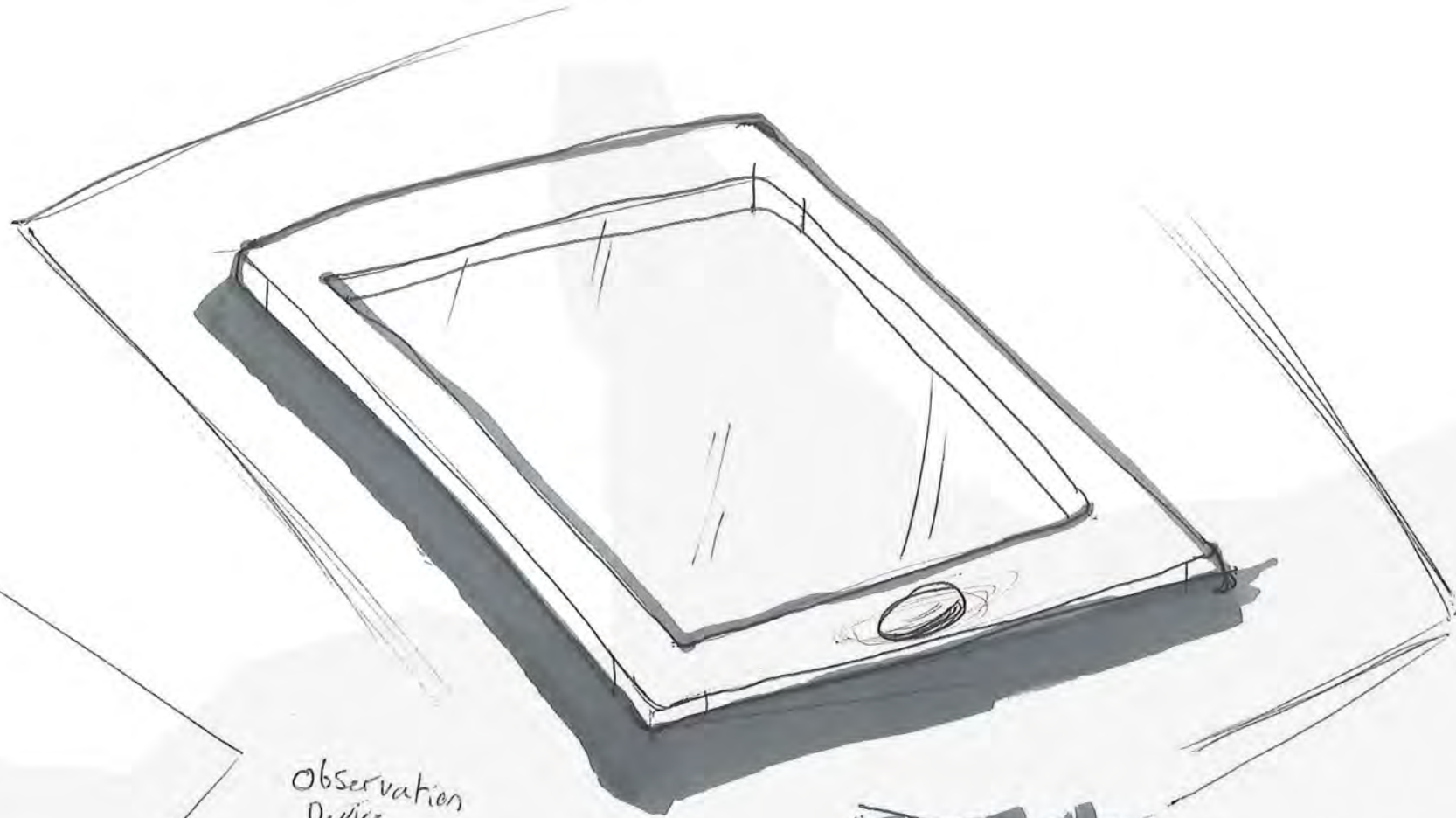
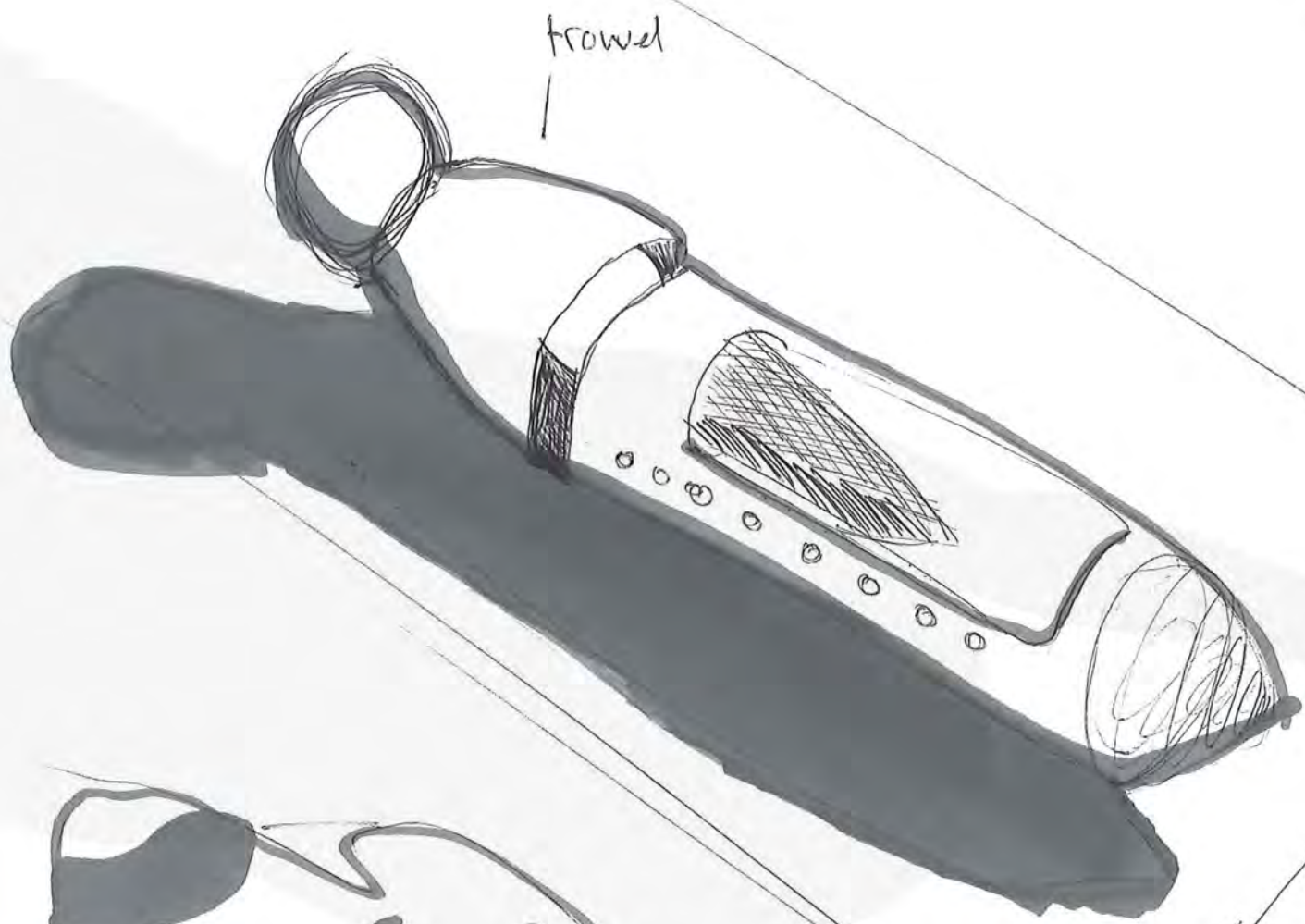

Observation Device

Black Border
to enhance viewing

disk tray
like opening

acrylic sheet
with different magnifications
Button release

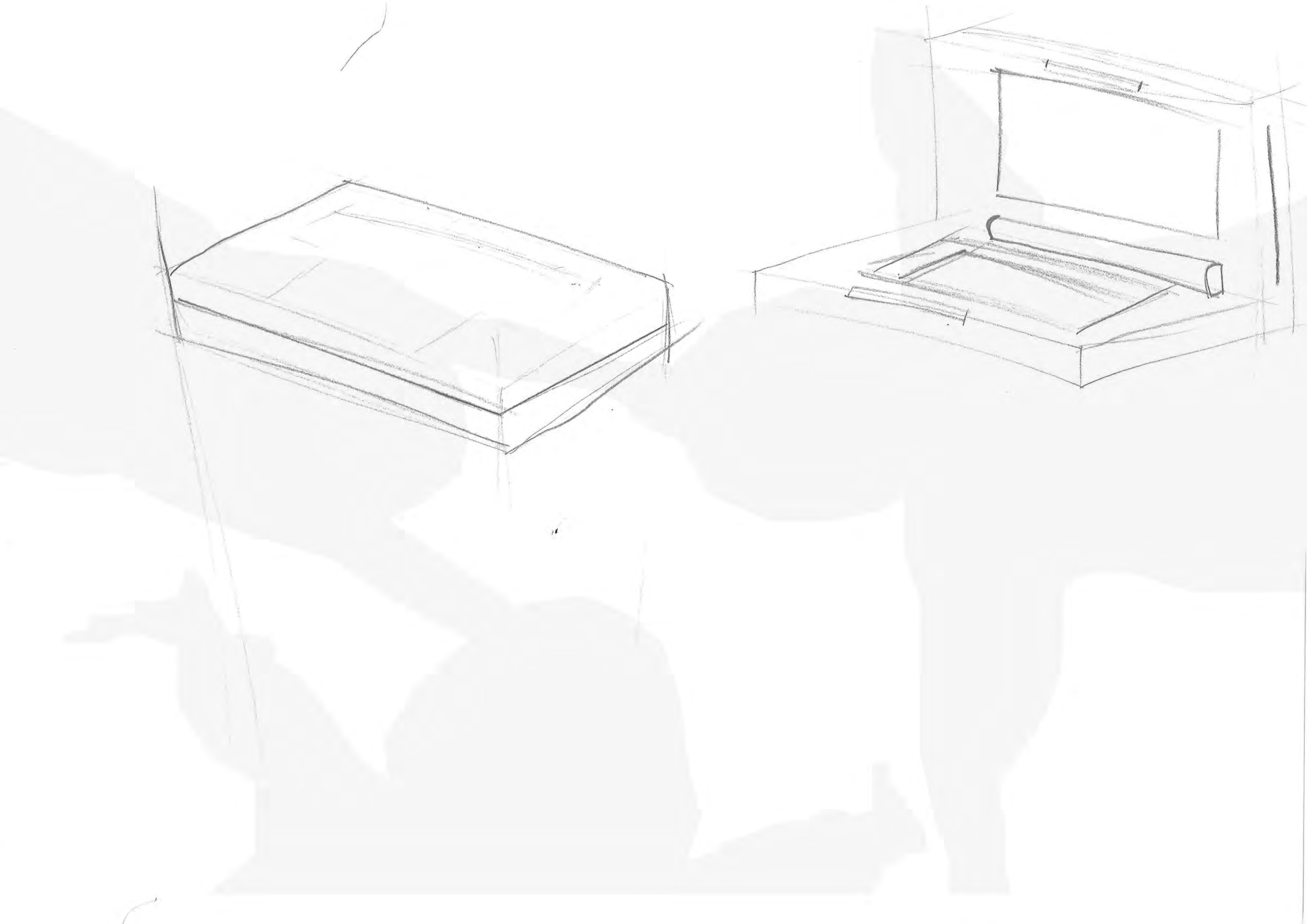

Insect design
 Smiling face
 will help attract
 the idea that
 insects can be
 fun to play with

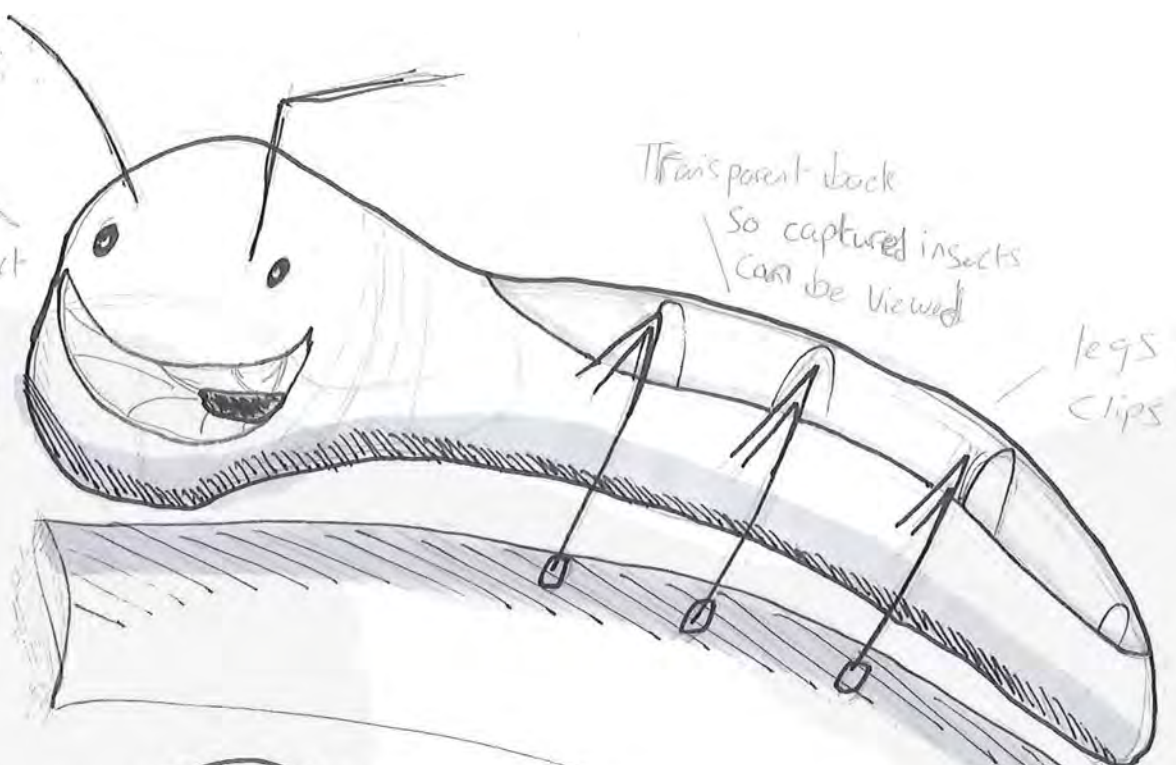

Transparent back
 so captured insects
 can be viewed

legs like bulldog
 clips



a track wide enough for
 common garden insects
 such as
 ants ladybugs
 wasps

soft
 gripping
 material
 to help stick
 to branches like shoes



Shoe grip

Bulldog Clip

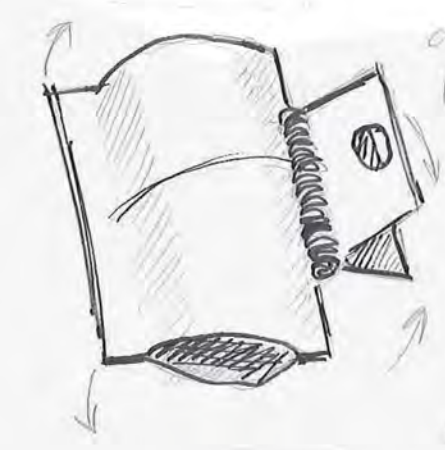

a mechanism
 like this
 will be useful
 for the insect
 catcher
 so it can
 attach to
 branches/
 trees



hanging on wires from tree or wall

Mouth for catch insects

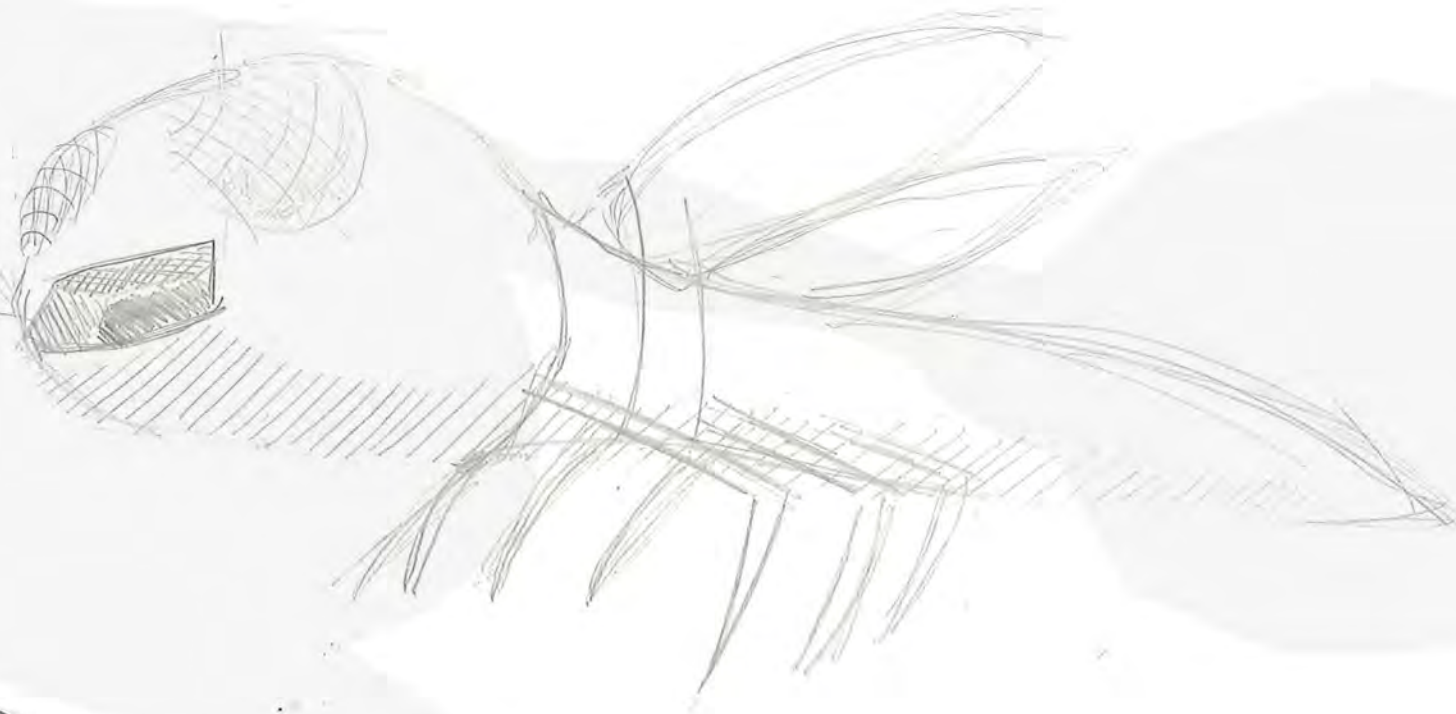

Insects bein' here



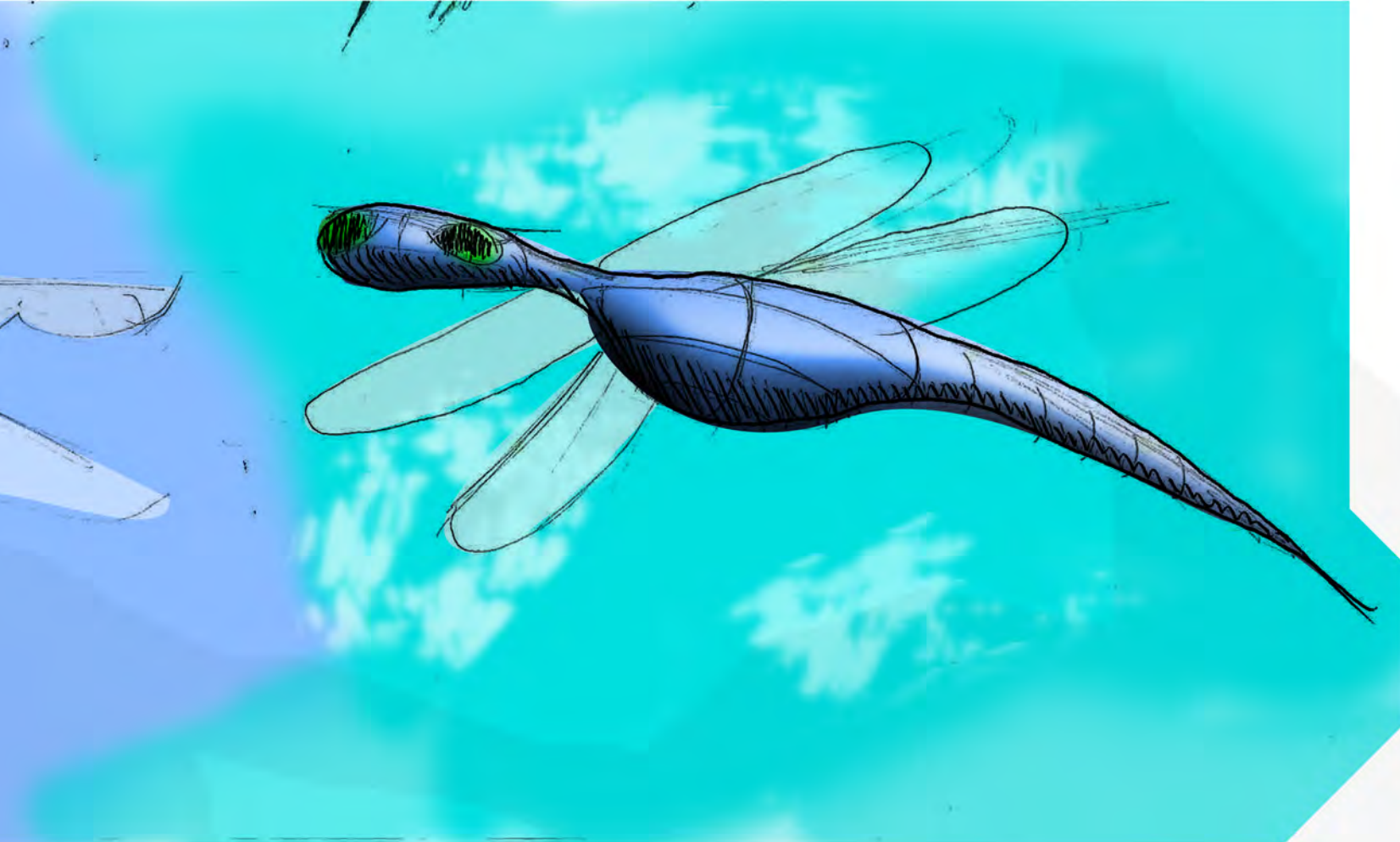

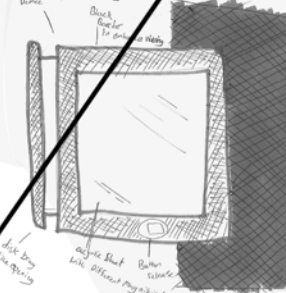
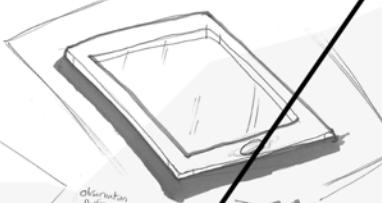
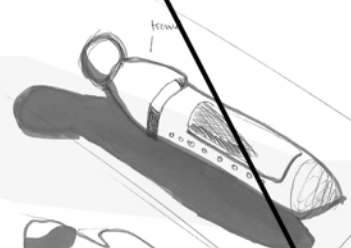
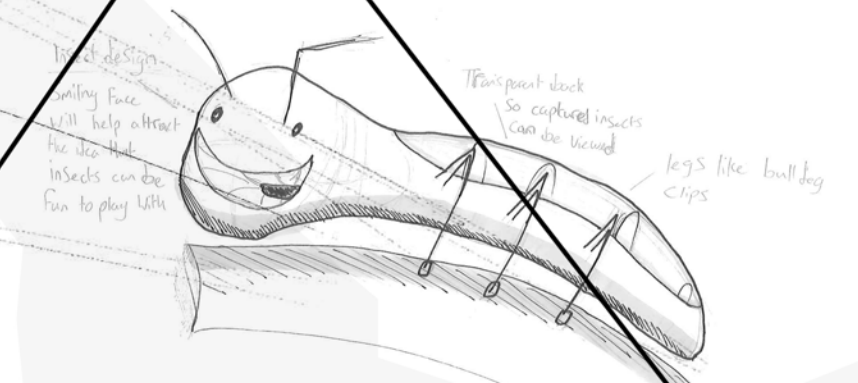
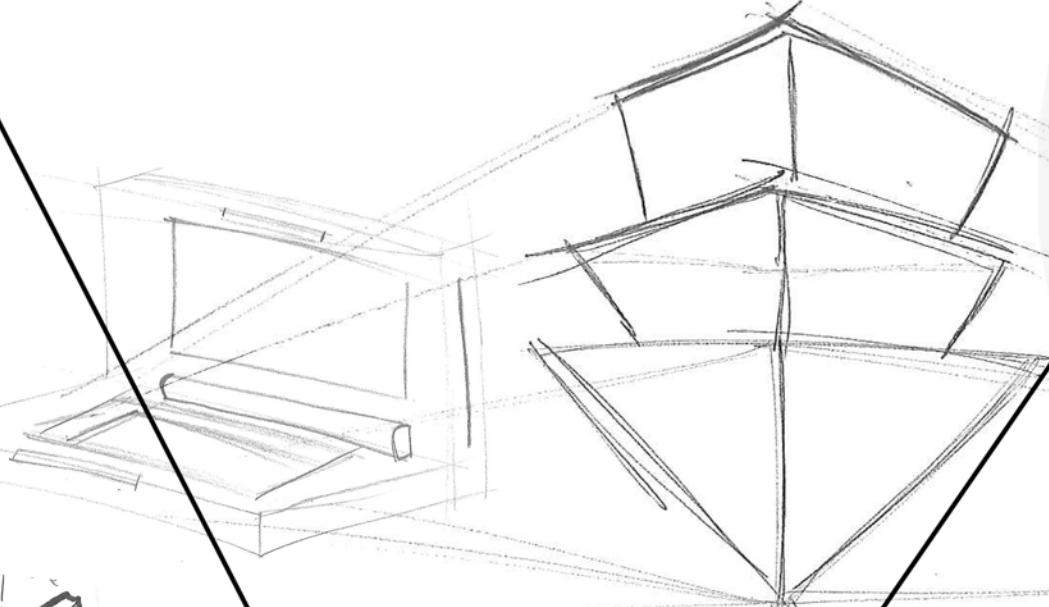
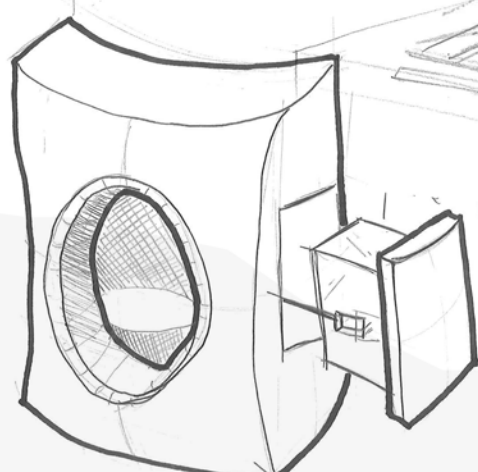

hanging on wires from the ceiling or wall

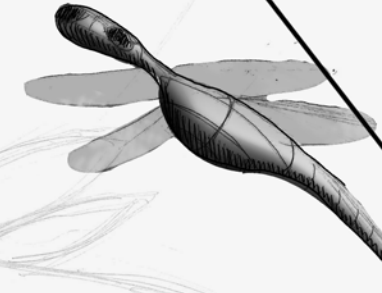

Mainly for growth caterpillars

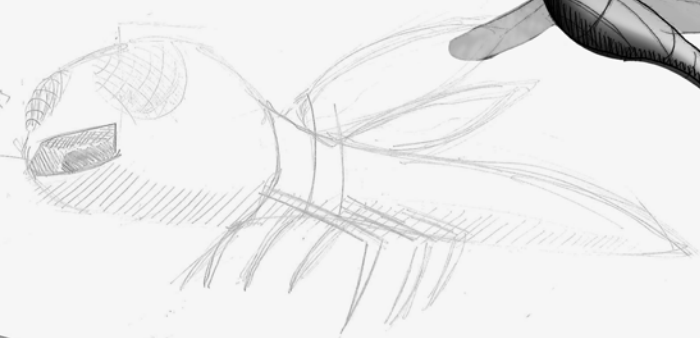

Insects would be here

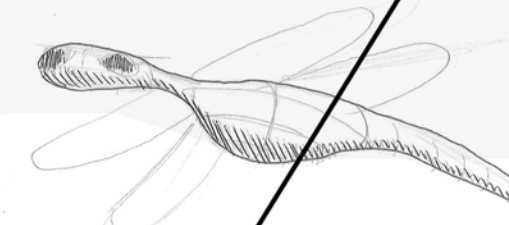

MIB

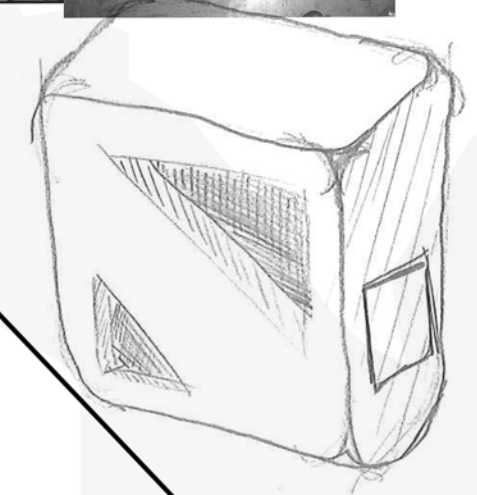
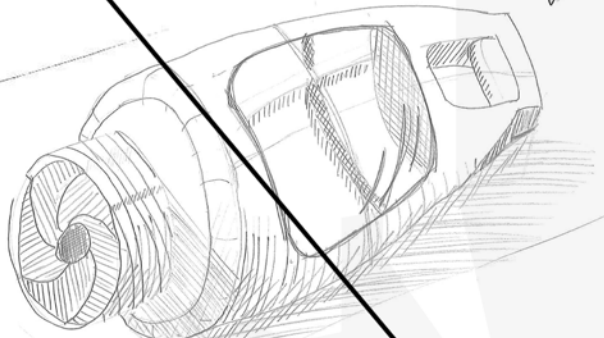
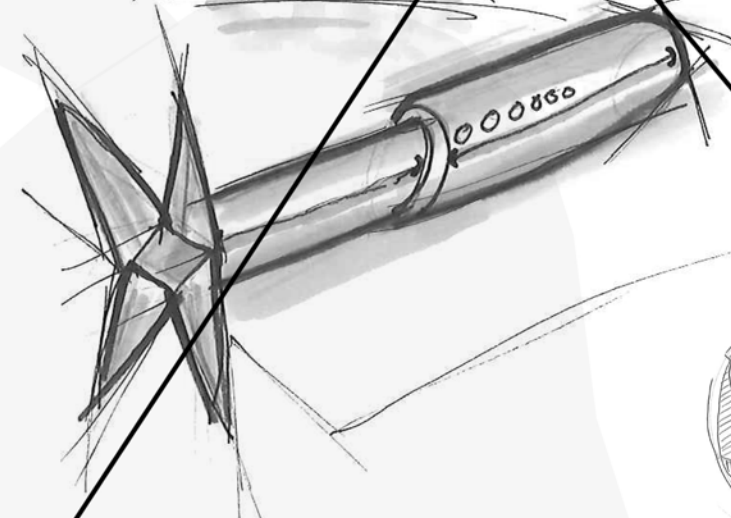

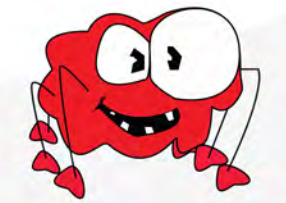
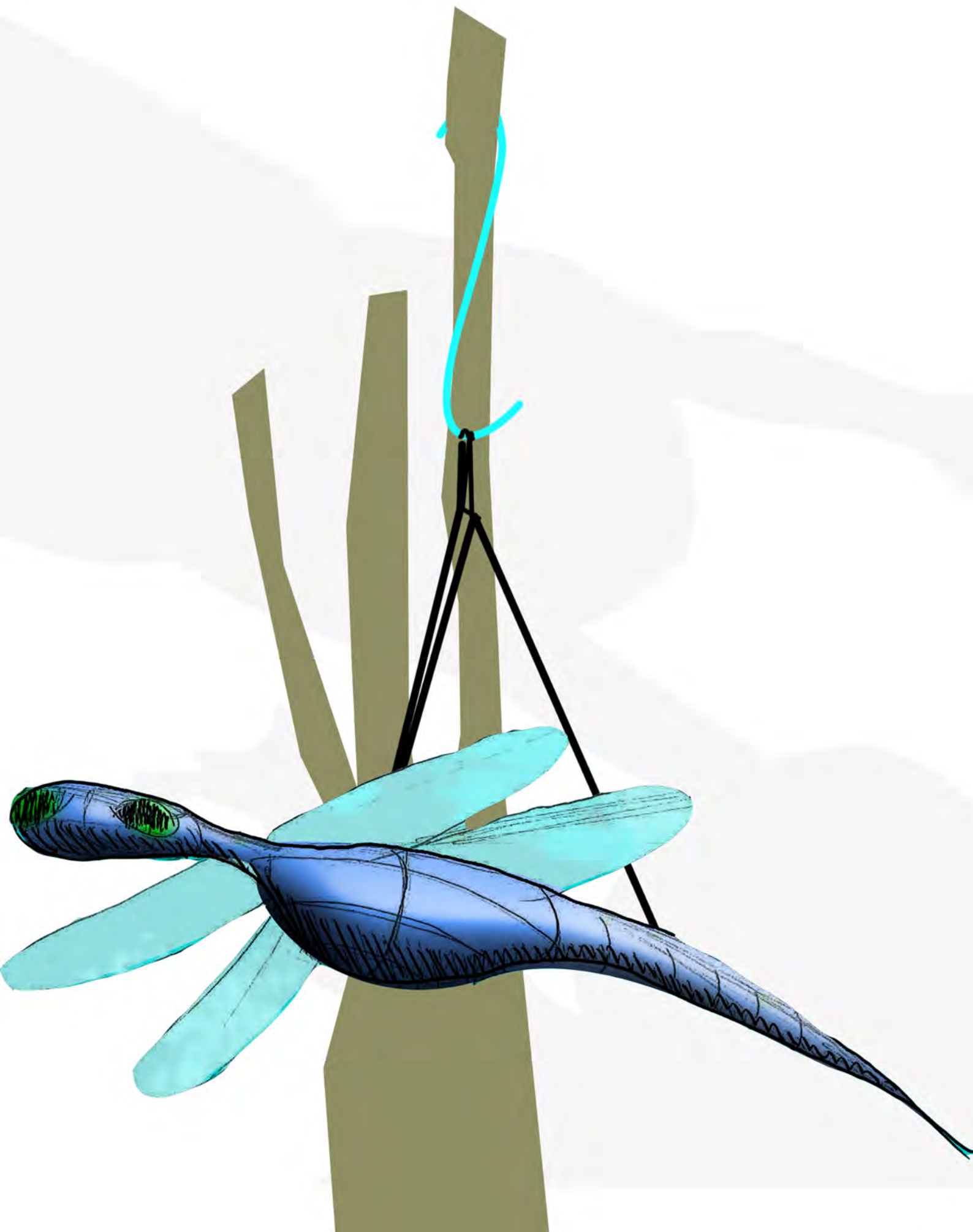

dragon fly

the passive catching device for children